

AEH60F48 /ALH60F48 Isolated DC/DC Converter Module

Industry Standard 1/2Brick – 36-75V Input, 3.3V / 60A Output

The AEH60F48 / ALH60F48 is part of Astec's New Ultra High Density 1/2Brick family capable of running 60Amps at 3.3V output. With Efficiencies up to 92% typical at 3.3V - 60Amps, this product provides a 1% to 2% performance increase in efficiency over the leading 60Amp competitors and up to 10% higher output current. The operating temperature range (-40°C to 85°C for the ALH; -40°C to 100°C baseplate for AEH) assures maximum application flexibility. New single-output models feature superior transient response with excellent stability in high capacitance/low ESR load applications. This family has an effective thermal adapter plate which allows for heat sinking under particularly harsh conditions. Without the adapter plate (ALH60) provides a very effective low profile which performs extremely well in convection cooled applications.

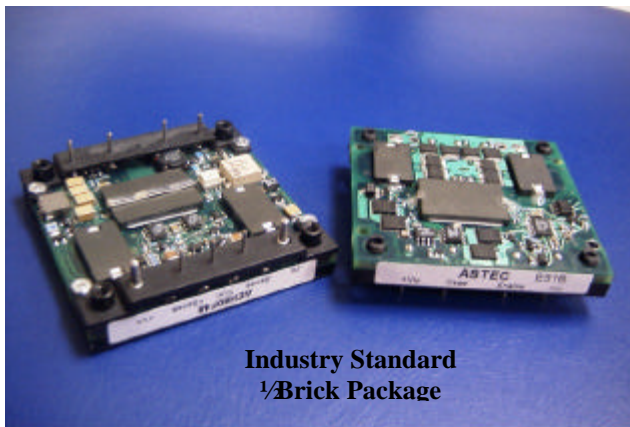

Special Features

- High efficiency, 92% (30-70%Load)
- -40°C to 100°C baseplate operating temp
- Open Frame version also available (ALH60)
- Positive and Negative enable function
- Low output ripple and noise
- High capacitive load limit
- Remote sense compensation
- Regulation to zero load
- Fixed frequency switching (190 KHz)

Environmental Specifications

- Operating temperature:
-40°C to +85°C for Open Frame (ALH60)
-40°C to +100°C (Baseplate) for (AEH60)
- Storage temperature: -40°C to +125C
- MTBF: >1 million hours

Electrical Parameters

Input

Input range	36-75 VDC
Input Surge	100V / 100ms
Efficiency	91% @ 3.3V (Typical @ 60 Amps)

Control

Enable	TTL compatible (Positive & Negative enable options)
--------	--

Output

Regulation (Line, Load, Temp)	<2%
Ripple and Noise	2% typical (100mV p-p max)
Remote Sense	Up to 10% Vout
Output Voltage Adjust Range	±10% of nominal output
Transient Response	150mV max deviation with 50% to 75% full load 300 μS (max) recovery
Over Voltage Protection	130% nominal

Safety

- UL, cUL 60950 Recognized
- EN 60950 through TUV-PS



AEH60 / ALH60 SERIES

THIS SPECIFICATION COVERS THE REQUIREMENTS
FOR AN INDUSTRY STANDARD HALF BRICK (MAX 198W @ 3.3V) SINGLE OUTPUT ULTRA HIGH
EFFICIENCY ISOLATED DCDC CONVERTER

MODEL NAME / SIS CODE	Construction	Vout, Iout
AEH60F48	HS Adapter	3.3V/60A
AEH60G48	HS Adapter	2.5V/60A
AEH60Y48	HS Adapter	1.8V/60A
AEH60K48	HS Adapter	1.2V/60A
ALH60F48	Open Frame 0.4"	3.3V/60A
ALH60G48	Open Frame 0.4"	2.5V/60A
ALH60Y48	Open Frame 0.4"	1.8V/60A
ALH60K48	Open Frame 0.4"	1.2V/60A

Options:

	Suffix
Negative Enable:	"N"
Positive Enable:	no suffix



Electrical Specifications

STANDARD TEST CONDITION on a single unit, unless otherwise specified.

T _A :	25°C (Ambient Air)
+V _{IN} :	48V ± 2%
-V _{IN} :	Return pin for +V _{IN}
Enable:	Open (Positive Enable)
+V _{OUT} :	Connect to Load
-V _{OUT} :	Connect to Load (return)
Trim (V _{ADJ}):	Open
+Sense:	Connect to +V _{OUT}
-Sense:	Connect to -V _{OUT}

ABSOLUTE MAXIMUM RATINGS

Stresses in excess of the absolute maximum ratings can cause permanent damage to the device. Functional operation of the device is not implied at these or any other conditions in excess of those given in the operational sections of the specs. Exposure to absolute maximum ratings for extended periods can adversely affect device reliability.

Parameter	Device	Symbol	Min	Typ	Max	Unit
Input Voltage:						
Continuous:	All	V _I	0	-	75	Vdc
Transient (100ms)	All	V _{I,trans}	0	-	100	Vdc
Operating Temperature	AEH	T _C	-40	-	100	°C
	ALH	T _A	-40	-	85	°C
Storage Temperature	All	T _{STG}	-55	-	125	°C
Operating Humidity	All	-	-	-	85	%
I/O Isolation (Conditions : 50µA for 5 sec, slew rate of 1500V/10sec)						
Input-Output	All	-	-	-	1500	Vdc
Input-Case	AEH	-	-	-	1500	Vdc
Output-Case	AEH	-	-	-	1500	Vdc
Output Power	3.3V	P _{O,max}	-	-	198	W



Electrical Specifications (continued)

INPUT SPECIFICATIONS

Parameter	Device	Symbol	Min	Typ	Max	Unit
Operating Input Voltage	All	V_{IN}	36	48	75	V_{DC}
Maximum Input Current ¹ ($V_{IN} = 0$ to $V_{IN,max}$; $I_O = I_{O,max}$)	F (3.3V)	$I_{IN,max}$	-	-	7.2	A
Input Reflected-ripple Current ² (5Hz to 20MHz; 12uH source impedance; $T_A = 25^\circ C$.)	All	I_I	-	-	15	mA_{PK-PK}
No Load Input Power ($V_{IN} = V_{IN,nom}$)	All	-	-	-	5	W

Note: 1. The power module is not internally fused. An input line fuse must always be used.
 2. See Figure 1 for the Input Reflected-Ripple Current Test Setup.

OUTPUT SPECIFICATIONS

Parameter	Device	Symbol	Min	Typ	Max	Unit
Output Voltage Setpoint ($V_{IN} = V_{IN,min}$ to $V_{IN,max}$ at $I_O = I_{O,max}$; $T_A = 25^\circ C$)	3.3V	$V_{O,SET}$	3.24	3.3	3.34	Vdc
Output Regulation:						
Line	All	-	-	0.1	0.4	%
Load ($I_O = I_{O,min}$ to $I_{O,max}$)	All	-	-	0.1	0.4	%
Temp (AEH: $-40^\circ C$ to $100^\circ C$) (ALH: $-40^\circ C$ to $85^\circ C$)	All	-	-	-	1.0	%Vo
Output Ripple and Noise ³ Peak-to-Peak (5 Hz to 20 MHz)						
$V_{IN} = 36V, 48V$	3.3V	-	-	66	100	mV_{PK-PK}
$V_{IN} = 75V$		-	-	-	150	mV_{PK-PK}
External Load Capacitance (See Stability Curves for Detail)	All	-	-	-	50,000	μF
Rated Output Current	All	I_o	0	-	60	A
Output Current-limit Inception (when unit is shut down)	All	I_o	63	-	77	A
Efficiency ⁴ ($V_I = V_{IN,nom}$; $I_{O,max}$; $T_A = 25^\circ C$)	3.3V	-	90	91	-	%
Switching Frequency	All	-	180	195	210	KHz

Note: 3. See Figure 2 for the Output Ripple Test Setup
 4. Refer to Figures 5 and 6 for the Efficiency Curves



Electrical Specifications (continued)

OUTPUT SPECIFICATIONS

Parameter	Device	Symbol	Min	Typ	Max	Unit
Dynamic Response ⁵ : ($\Delta I_O/\Delta t = 1A/10\mu s$; $V_I = V_{IN,nom}$; $T_A = 25^\circ C$)						
Load Change from $I_O = 50\%$ to 75% of $I_{O,max}$:	All	-	-	-	150	mV
Peak Deviation Settling Time (to $V_{O,nom}$)		-	-	-	300	μsec
Load Change from $I_O = 50\%$ to 25% of $I_{O,max}$:	All	-	-	-	150	mV
Peak Deviation Settling Time (to $V_{O,nom}$)		-	-	-	300	μsec
Turn-On Time ($I_O = I_{O,max}$; V_O within 1%)	All	-	-	4	10	msec
Output Voltage Overshoot ($I_O = I_{O,max}$; $T_A = 25^\circ C$)	All	-	-	0	4	% V_O

Note: 5. Refer to the Transient characteristics on Figures 7 and 8.

FEATURE SPECIFICATIONS

Parameter	Device	Symbol	Min	Typ	Max	Unit
Enable Pin Voltage :						
Logic Low	All		-0.7	-	1.2	V
Logic High	All		2.95	-	10	V
Enable Pin Current :						
Logic Low	All		-	-	1.0	mA
Logic High ($I_{LEAKAGE}$ at 10V)	All		-	-	50	μA
Module Output Voltage @ Logic Hi	AEH/ALH60x48N		-	-	0.2	V
Module Output voltage @ Logic Low	AEH/ALH60X48		-	-	0.2	V
Output Voltage Adjustment Range ⁶	All	-	90	-	110	% V_O
Output Overvoltage Clamp	3.3V	$V_{O,CLAMP}$	3.90	4.10	5.00	V
Undervoltage Lockout						
Turn-on Point	All	-	34.0	34.8	35.5	V
Turn-off Point	All	-	33.0	33.5	34.5	V
Isolation Capacitance	All	-	-	2700	-	PF
Isolation Resistance	All	-	10	-	-	$M\Omega$
Calculated MTBF ($I_O = I_{O,max}$; $T_A = 25^\circ C$)	All	-	-	TBD	-	Hours

Note: 6. For Output Voltage Adjustment setup, refer to Figures 3 and 4.

SAFETY APPROVAL

The series have been certified through:

- UL, cUL 60950 (Recognized)
- EN 60950 through TUV- PS

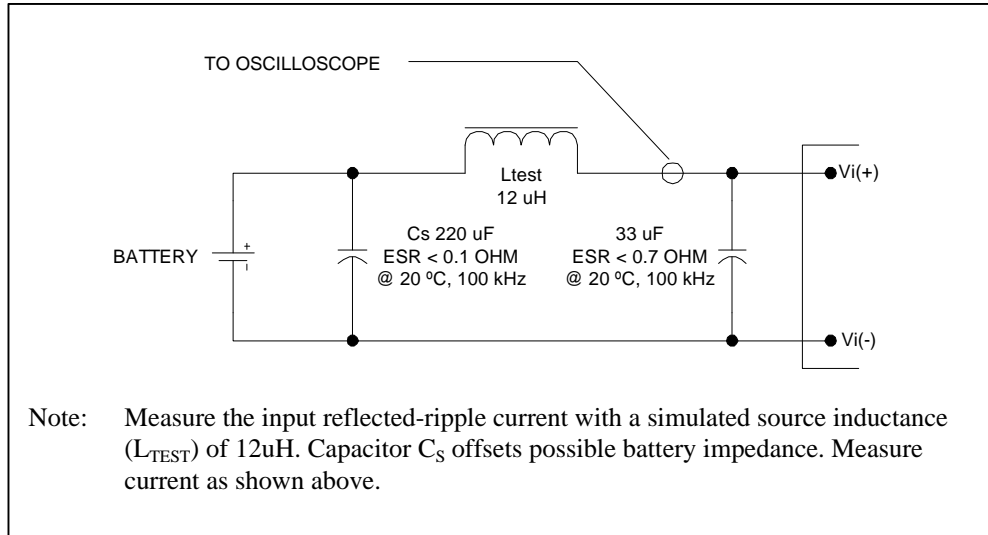

Figure 1. Input Reflected -Ripple Test Setup

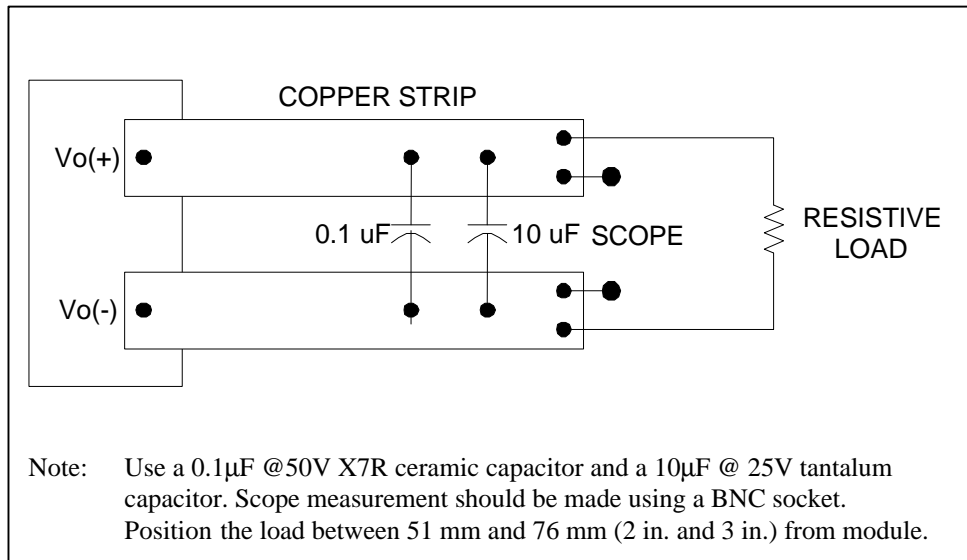

Figure 2. Peak to Peak Output Noise and Ripple Test Measurement Setup

Basic Operation and Features

AEH60 / ALH60 converters were designed specifically to address applications where ultra high power density is required. These modules provide basic insulation and 1500V isolation with very high output current capability in an industry standard half size module. Operating from 36 to 75V input, they have standard features such as remote sense, trim, OVP, OCP and OTP. AEH60 series devices will accept industry standard heat sinks to enhance thermal performance in applications with conductive cooling.

Remote Sense (+Sense, -Sense)

Connect the + Sense and – Sense pins close to the load to allow the module to compensate for the voltage drop across conductors carrying high load current. If remote sense is not required (for example if the load is close to the module) the sense pins should be connected to the corresponding output pins. Maximum voltage drop compensation is 10% V_{out} . It is important to avoid introducing lumped inductance or capacitance into the remote path. Do not connect remote sense lines “beyond” any external output filter stages used with the module.

Trim Function

Output voltage adjustment is accomplished by connecting an external resistor between the Trim Pin and either the +Sense or –Sense Pins.

To adjust V_o to a higher value, please refer to Figure 3. An external resistor, **Radj_up** should be connected between the Trim Pin and the +Sense Pin. From Equation (1), Radj_up resistor can be determined for the required output voltage increment.

Equation (1)

$$Radj_up = \left[\frac{V_o \cdot (100 + \%V_o,adj)}{1.225 \cdot \%V_o,adj} - \frac{100 + 2\%V_o,adj}{\%V_o,adj} \right] \text{ kohm}$$

where: Radj_up - in k Ω
 % V_o, adj - percent change in output voltage

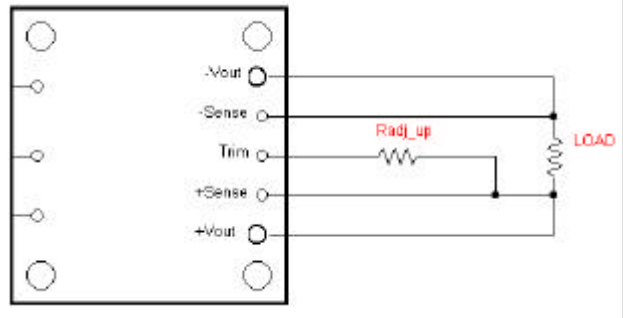

Figure 3. Radj_up Setup to increase Output Voltage

To adjust V_o to a lower value, please refer to Figure 4. An external resistor, **Radj_down** should be connected between the Trim Pin and the -Sense Pin. From Equation (2), Radj_down resistor can be determined for the required output voltage change.

Equation (2)

$$Radj_down = \left(\frac{100}{\%V_o,adj} - 2 \right) \cdot \text{kohm}$$

where: Radj_down - in k Ω
 % V_o, adj - percent change in output voltage

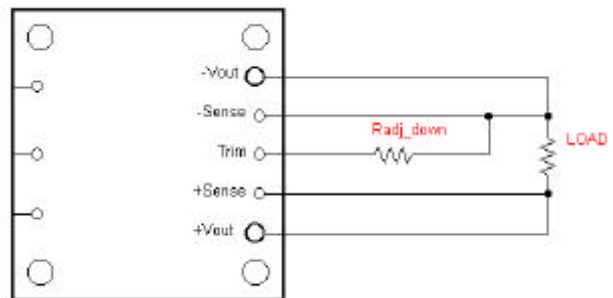

Figure 4. Radj_down Setup to decrease Output Voltage



Technical Reference Notes Hercules (AEH/ALH60) Open Frame or HS Adapted



Basic Operation and Features *(continued)*

Output Over Voltage Protection

The output over voltage system consists of a separate control loop, independent of the primary feedback path. This control loop has a higher voltage set point than the main circuit. In a fault condition, the converter latches which ensures that the output voltage does not exceed $V_{O,CLAMP,max}$. The converter will operate back normally once the fault is removed and the input voltage is cycled or the enable pin is toggled.

Output Over Current Protection

To provide protection in an output overload or short circuit condition, the converter is equipped with current limiting circuitry and can endure fault conditions for an unlimited duration. At the point of current-limit inception, the converter latches, causing the output current to be limited both in peak and duration. The converter will operate back normally once the overload/ fault is removed and the input voltage is cycled or the enable pin is toggled.

Enable Function

Two enable options are available. Positive Logic Enable (no suffix required in part number) and Negative Logic Enable (suffix "N"). Positive Logic Enable turns the converter on during a logic-high voltage on the enable pin, and off during a logic-low. Negative Logic Enable turns the converter off during a logic-high and on during a logic-low.

Performance Curves

EFFICIENCY

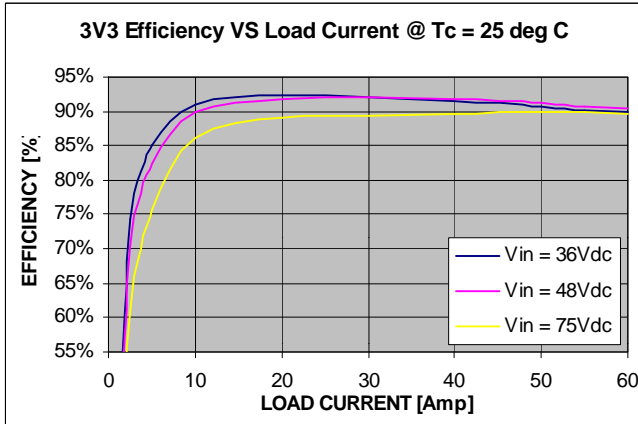

Figure 5. AEH/ALH60 3V3 Efficiency Curve at T_c = 25°C

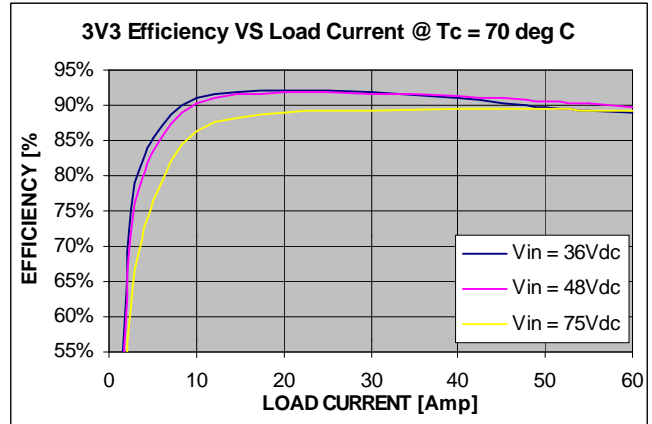

Figure 6. AEH/ALH60 3V3 Efficiency Curve at T_c = 70°C

TRANSIENT RESPONSE

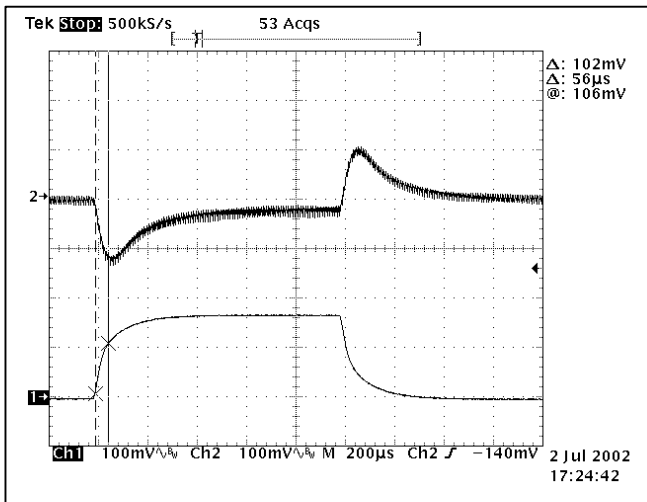

Figure 7. 3V3 output: 50% to 75% load change with no external capacitor at 0.1A/uS slew rate (CH1 at 1A/10mV).

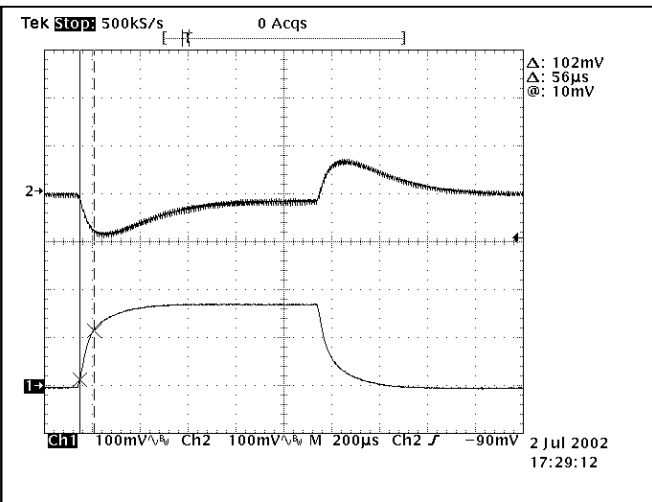

Figure 8. 3V3 output: 50% to 75% load change with 10,000uF external capacitor at 0.1A/uS slew rate (CH1 at 1A/10mV).

Performance Curves (continued)

CURRENT VS TEMPERATURE CURVES

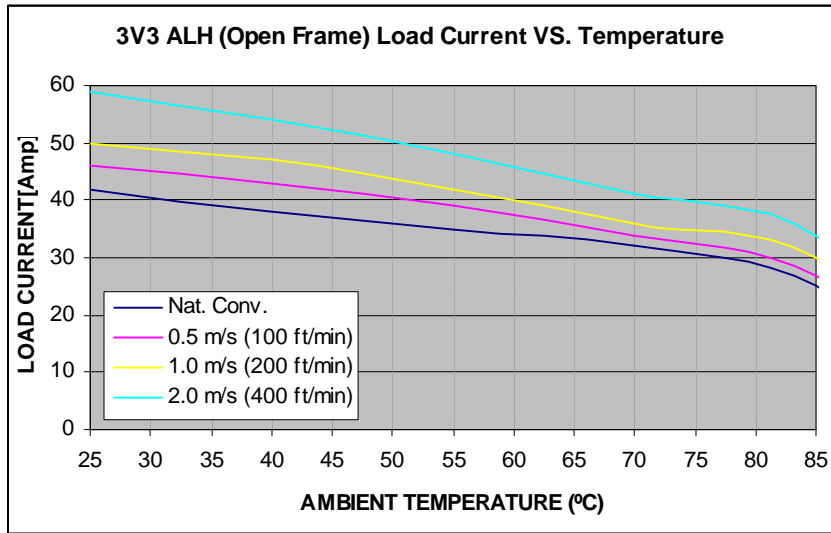

Figure 9. Load Current VS. Temperature (Open Frame)

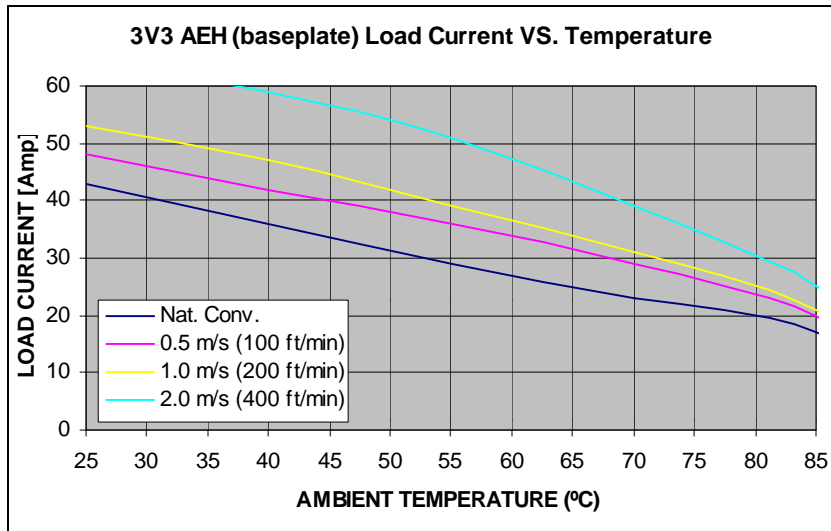

Figure 10. Load Current VS. Temperature (Baseplate)

Performance Curves (continued)

STARTUP CHARACTERISTICS

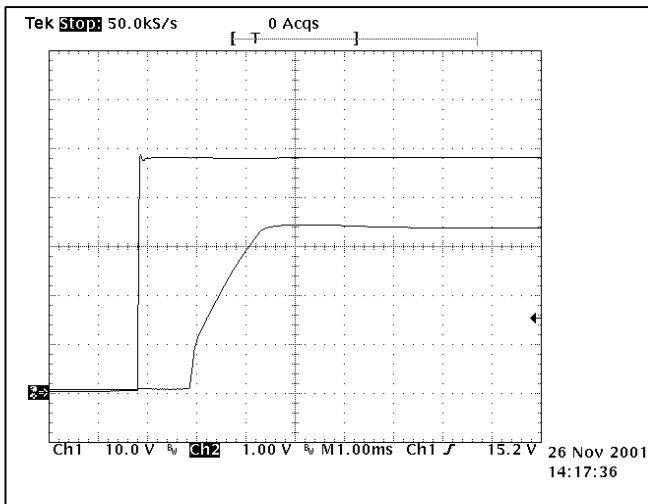

Figure 11. AEH60F48 (3.3V): O/P startup characteristic with no external capacitor at $V_{in} = 48V / 20A$ resistive load

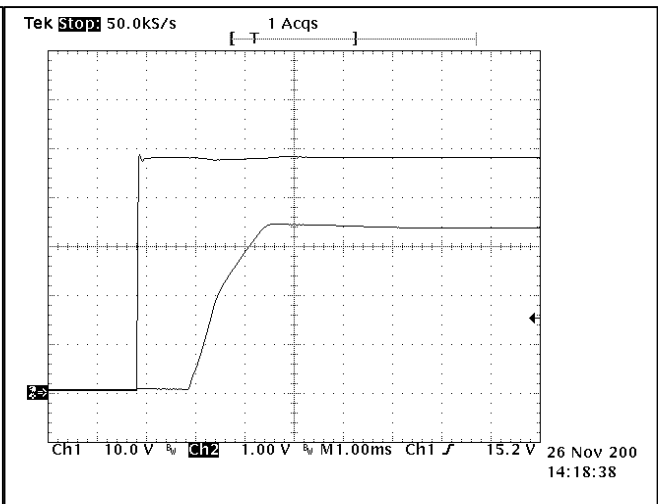

Figure 12. AEH60F48 (3.3V): O/P startup characteristic with 9400 uF external capacitor at $V_{in} = 48V / 20A$ resistive load.

Input Filter for FCC Class B Conducted Noise

A reference design for an input filter that can provide FCC Class B conducted noise levels is shown below (See Figure 13). Two common mode connected inductors are used in the circuit along with balanced bypass capacitors to shunt common mode currents into the ground plane. Shunting noise current back to the converter reduces the amount of energy reaching the input LISN for measurement.

The application circuit shown has an earth ground (frame ground) connected to the converter output (-) terminal. Such a configuration is common practice to accommodate safety agency requirements. Grounding an output terminal results in much higher conducted emissions as measured at the input LISN because a hard path for common mode current back to the LISN is created by the frame ground. “Floating” loads generally result in much lower measured emissions. The electrical equivalent of a floating load, for EMI measurement purposes, can be created by grounding the converter output (load) through a suitably sized inductor(s) while maintaining the necessary safety bonding.

Also shown is a sketch of a PCB layout used to achieve Class B conducted noise levels (See Figure 14). It is important to avoid extending the ground plane or any other conductors under the inductors (particularly L2) because capacitive coupling to that track or plane can effectively bypass the inductor and degrade high frequency performance of the filter.

PARTS LIST

CIRCUIT CODE	DESCRIPTION
L1, L2	Pulse Engineering P0353 / 590uH
C1, C3, C4, C5, C6, C11, C12	0.01uF / 2000V
C2, C7, C9	100uF / 100V Aluminum
C13, C14	470pF / 100V Ceramic
C8, C10	2.2uF / 100V Film

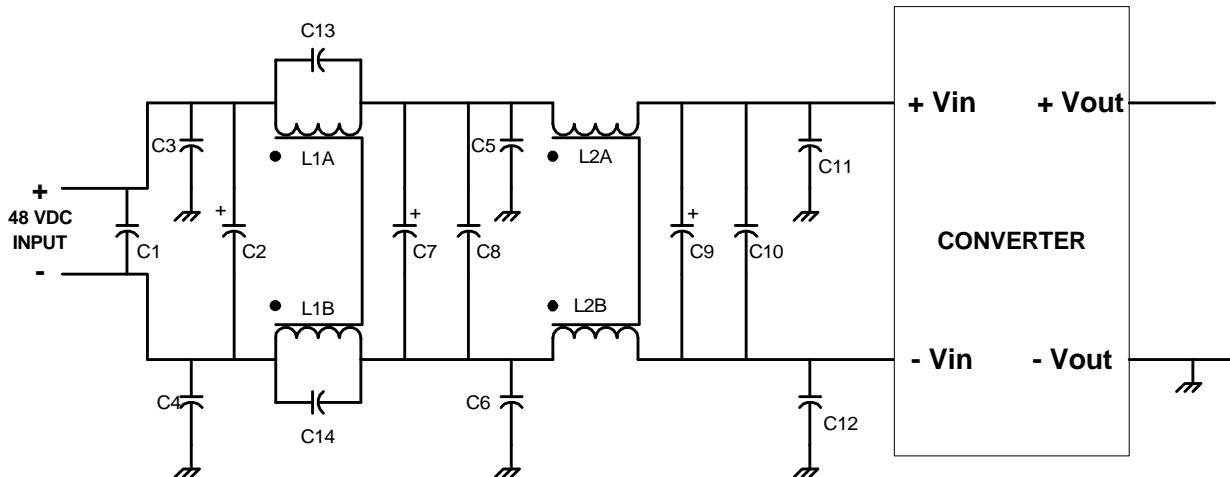

Figure 13: Class B Filter Circuit

Input Filter for FCC Class B Conducted Noise *(continued)*

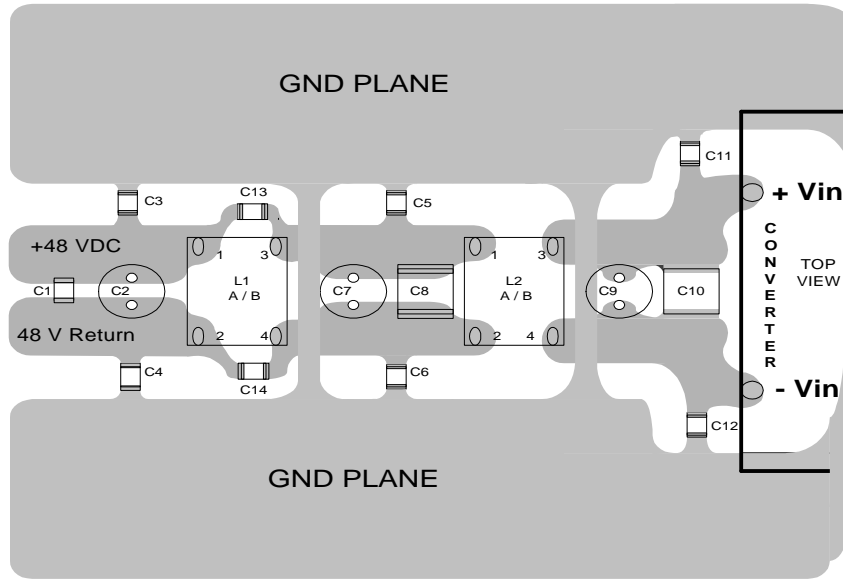

Figure 14: Recommended PCB Layout for Class B Filter

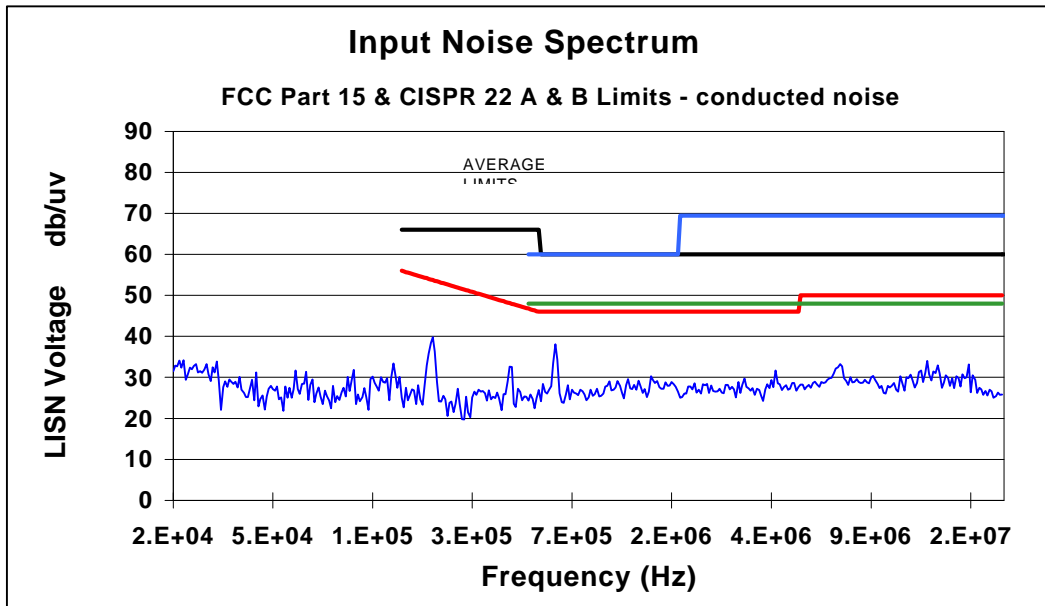

Figure 15: AEH60F48 and ALH60F48 Noise Spectrum

Thermal Considerations

While the ALH60 (Open Frame Converter) is designed to provide the maximum performance at the lowest profile, the AEH60 (Power Converter with HS adapter) operates in a variety of thermal environments. Sufficient cooling should be provided to help ensure reliable operation of either device. Heat generating components are thermally coupled to the adapter where heat energy is removed by conduction, convection, and radiation to the surrounding environment. Heat sinks can provide enhanced output performance as shown below. Proper cooling can be verified by measuring the case temperature (Center of adapter plate/baseplate).

HEAT TRANSFER CHARACTERISTICS

Increasing airflow over the converter enhances heat transfer via convection. Figure 16 shows worst case maximum power that can be dissipated by the converter, without exceeding the maximum adapter plate temperature, versus local ambient temperature (T_A) for natural convection through 2.0 m/s (400 ft/min). Figure 17 shows actual maximum power that can be dissipated through both the adapter plate and through the output pins (unit soldered into a 4" square copper plane (2 Oz.) or equivalent).

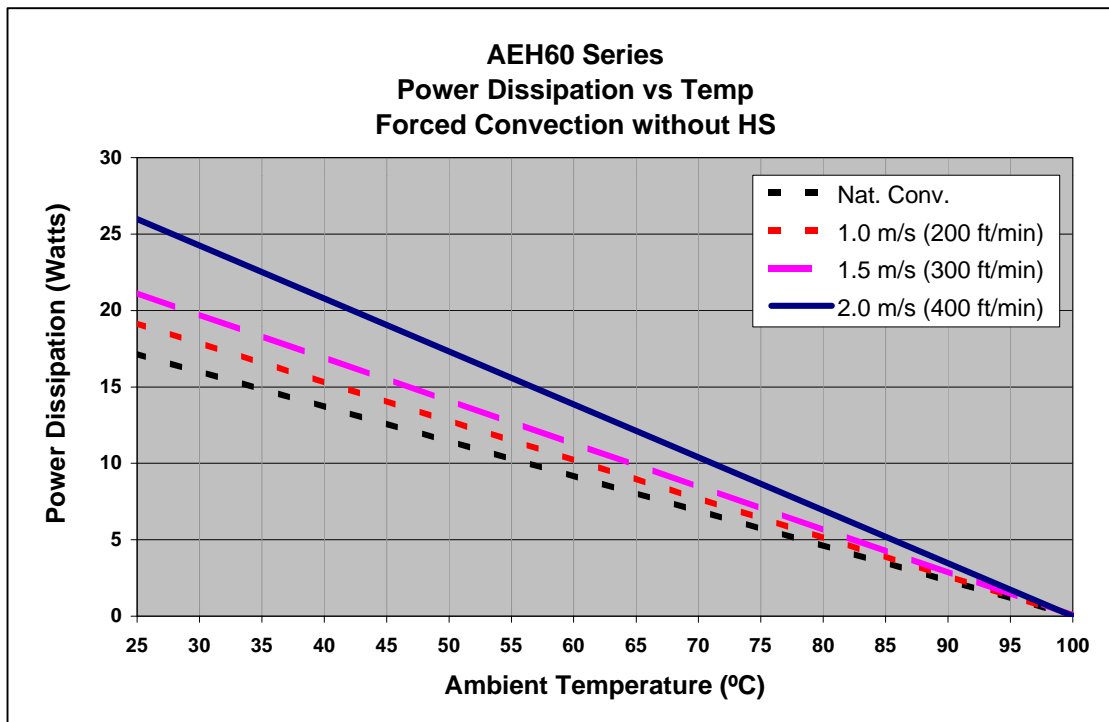

Figure 16. Forced Convection Power Dissipation

Note: This is worst case dissipation - additional Heat transfer through O/P pins will increase allowable dissipation considerably. See Figure 17.

Thermal Considerations (continued)

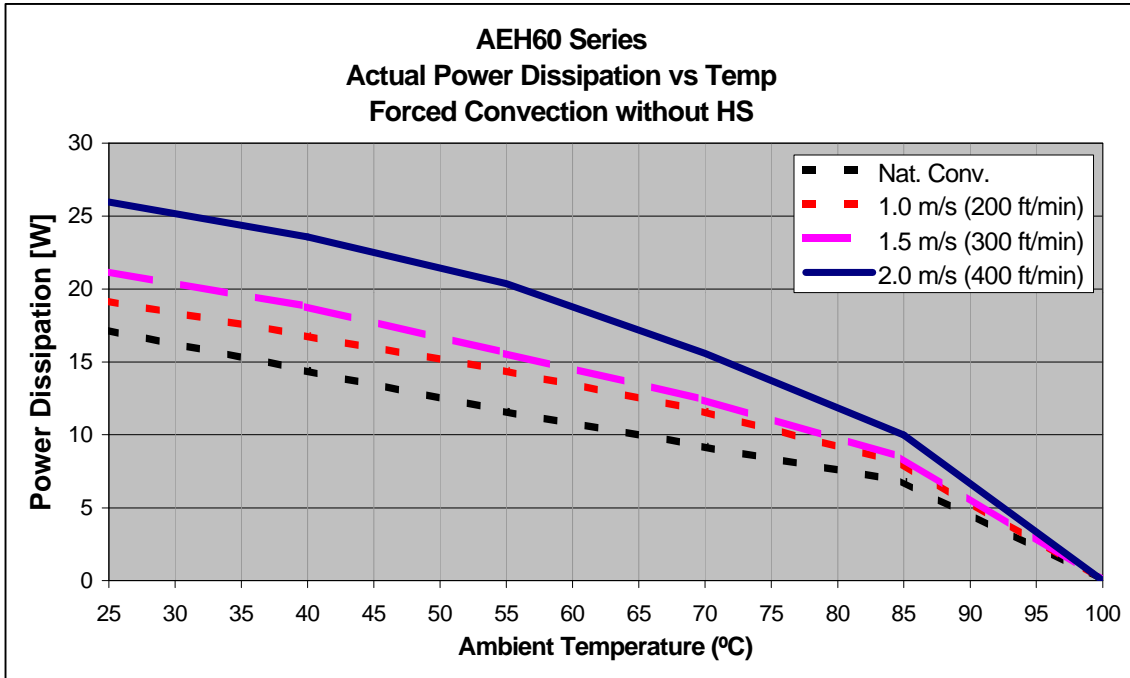

Figure 17. Actual Measured Forced Convection Power Dissipation

Note: This is an actual measured maximum dissipation with heat transfer through output pins included.

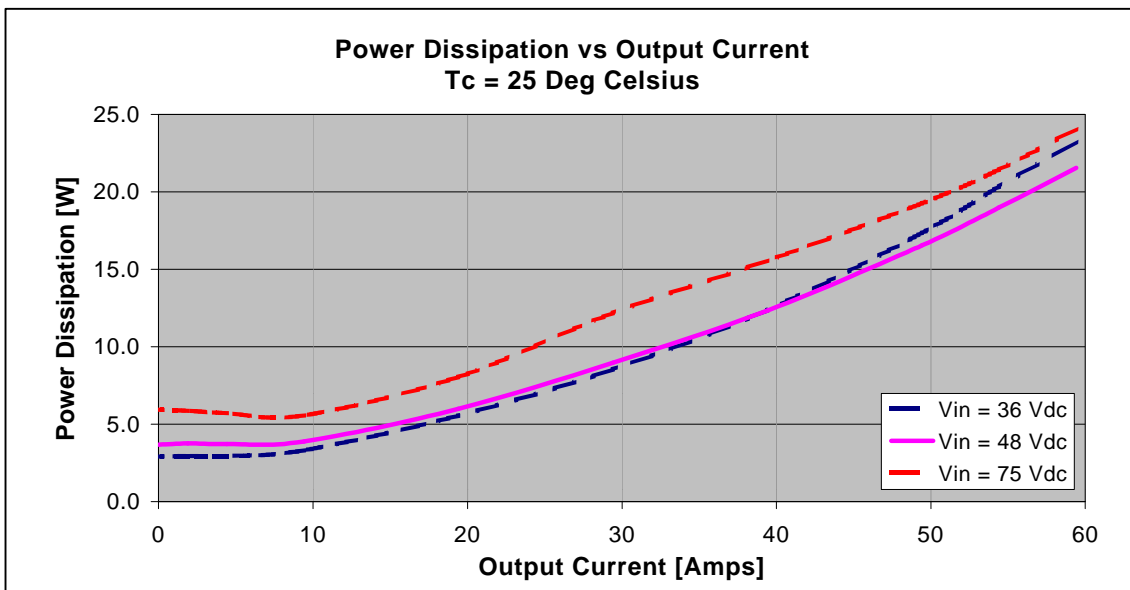

Figure 18. ALH/AEH60F48 Power Dissipation VS. Load Current.

Thermal Considerations *(continued)*

HEATSINK SELECTION ILLUSTRATED

Figure 19 shows Case-to-Ambient Thermal Resistance, θ ($^{\circ}\text{C}/\text{W}$), for AEH / ALH60 modules. These curves can be used to predict which heat sink will be needed for a particular environment. As an illustration, let's refer to below application requirement:

An application requires 45 Amps of 3.3V in a 55 $^{\circ}\text{C}$ environment with airflow of 1.0 m/s (200 ft/min); the minimum heat sink required can be determined through Equation (3).

$$\text{Equation (3)} \quad \theta \leq (T_{C, \text{MAX}} - T_A) / P_D$$

- where:
- θ = Module's Total Thermal Resistance
 - $T_{C, \text{MAX}}$ = Case Temperature (100 $^{\circ}\text{C}$)
 - T_A = Ambient Temperature (55 $^{\circ}\text{C}$)
 - P_D = Power Dissipation (15W)

From Figure 18, the power dissipation for a 45A-load requirement can be determined ($P_D = 15\text{W}$). Through Equation (3), the Thermal Resistance can be calculated to be at **at q £ 3.0 $^{\circ}\text{C}/\text{W}$** .

Based on Figure 19, the **1/4" HS (heatsink)**, or greater, will be able to handle the required 45A-load at 55 $^{\circ}\text{C}$ environment and with 1.0 m/s (200 ft/min) airflow.

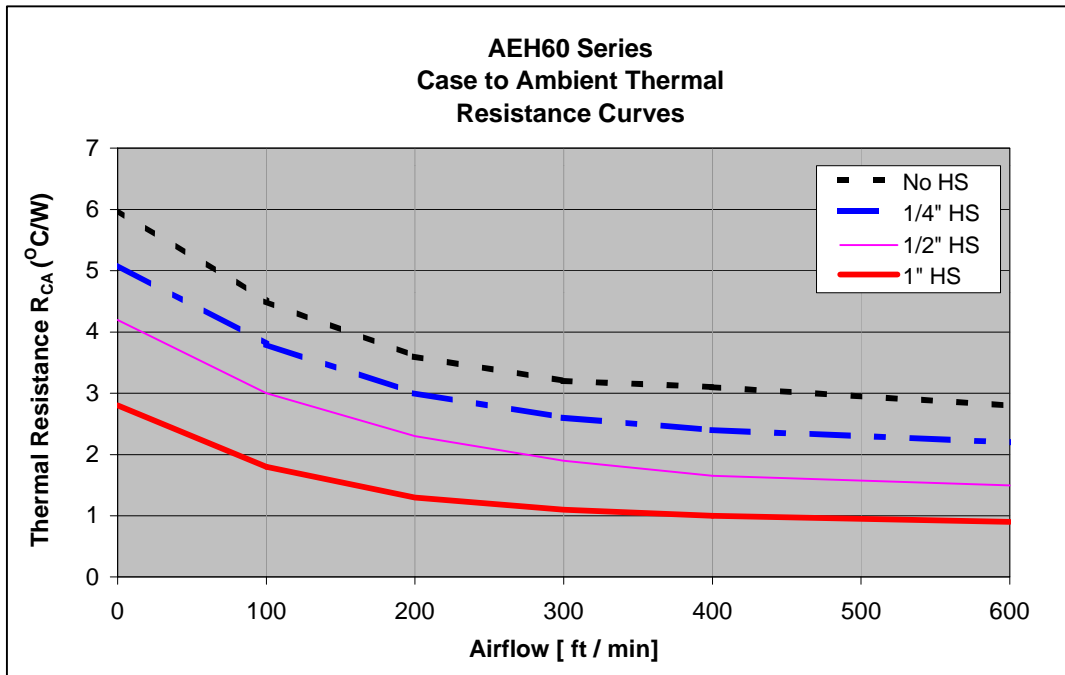

Figure 19. Case-to-Ambient Thermal Resistance vs. Air Velocity

Stability: Figures 20 and 21 are plots of internal Module Loop Gain and Phase Shift vs Frequency. Curves for typical resistive and reactive loads are shown. System stability (Phase and Gain Margins) when the module is connected to other loads can be determined from the Young's Stability Curves on Figures 23 and 24. Figure 22 shows an operating zone in which phase margin can be determined for virtually any load resistance and shunt capacitance. See Ref. 1 for application of curves.

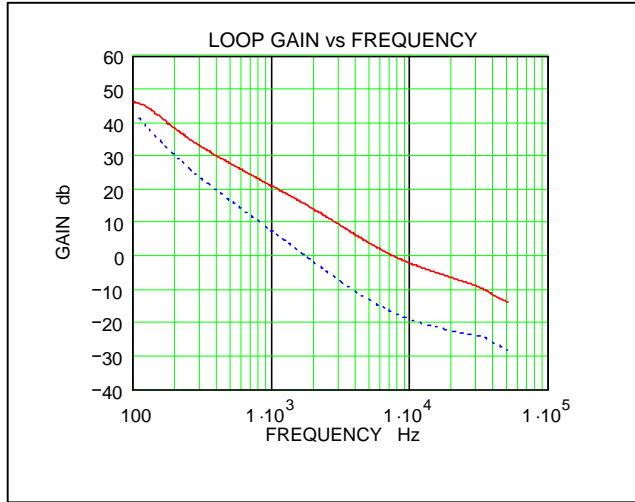

Figure 20. Loop Gain VS. Frequency at 0.171Ω load with no output capacitance,

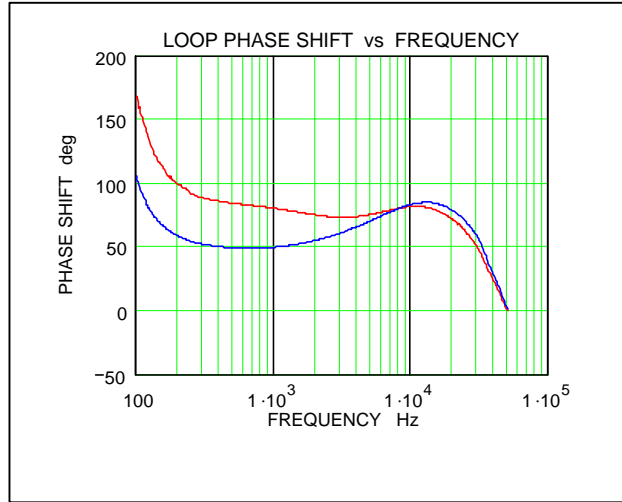

Figure 21. Phase Shift VS. Frequency at 0.171Ω load with 9400uF cap load (3.9mΩ ESR)



Figure 22: Phase Margin vs Load Resistance

Young's Stability Curves

PHASE MARGIN

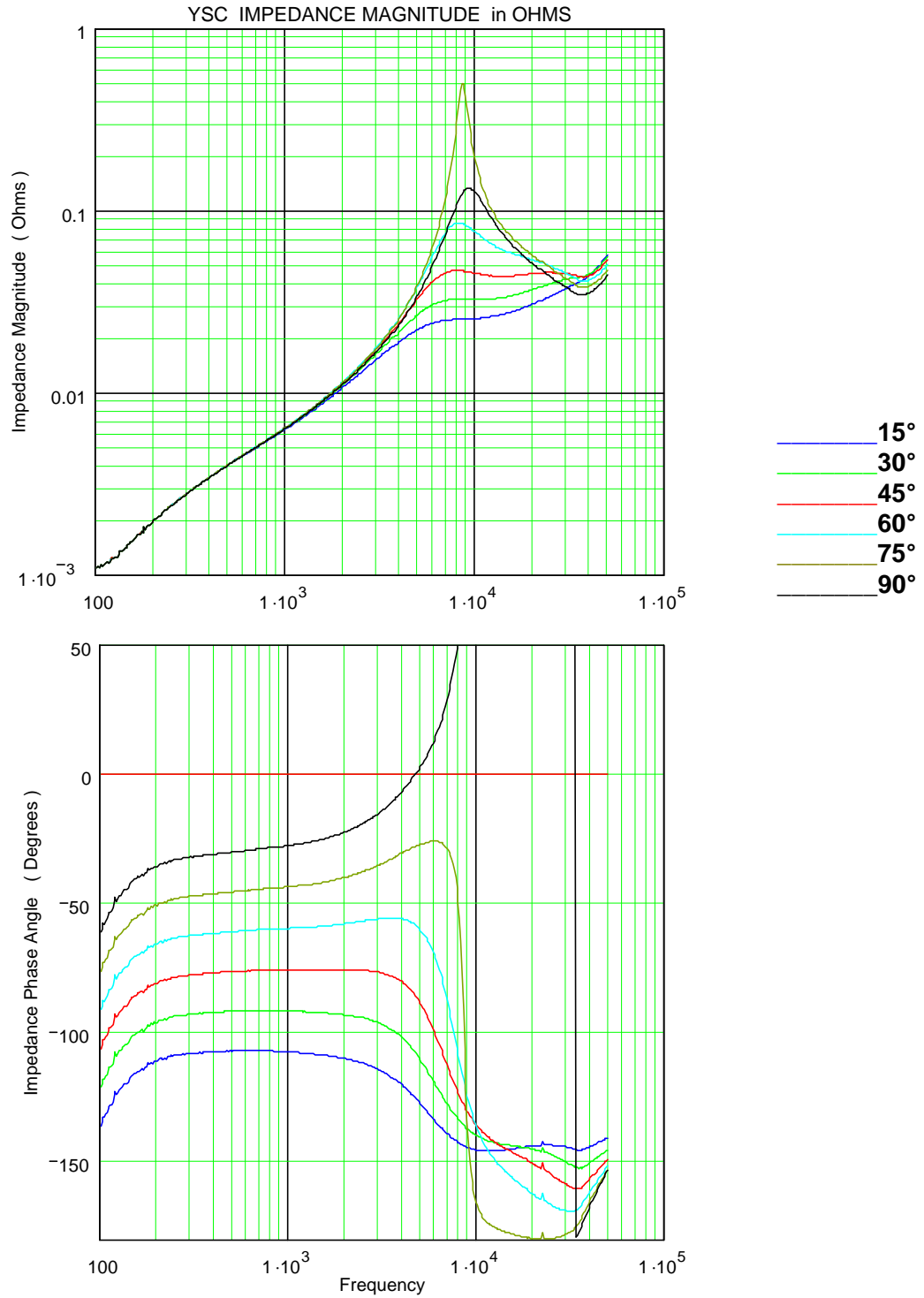

Figure 23. Young's Stability Curve – Phase Margin

Young's Stability Curves

GAIN MARGIN

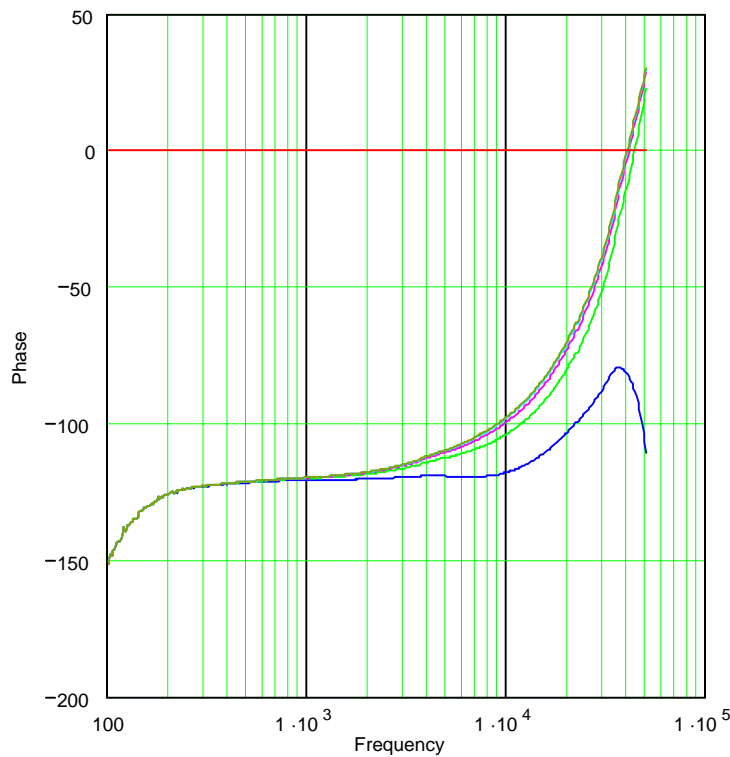
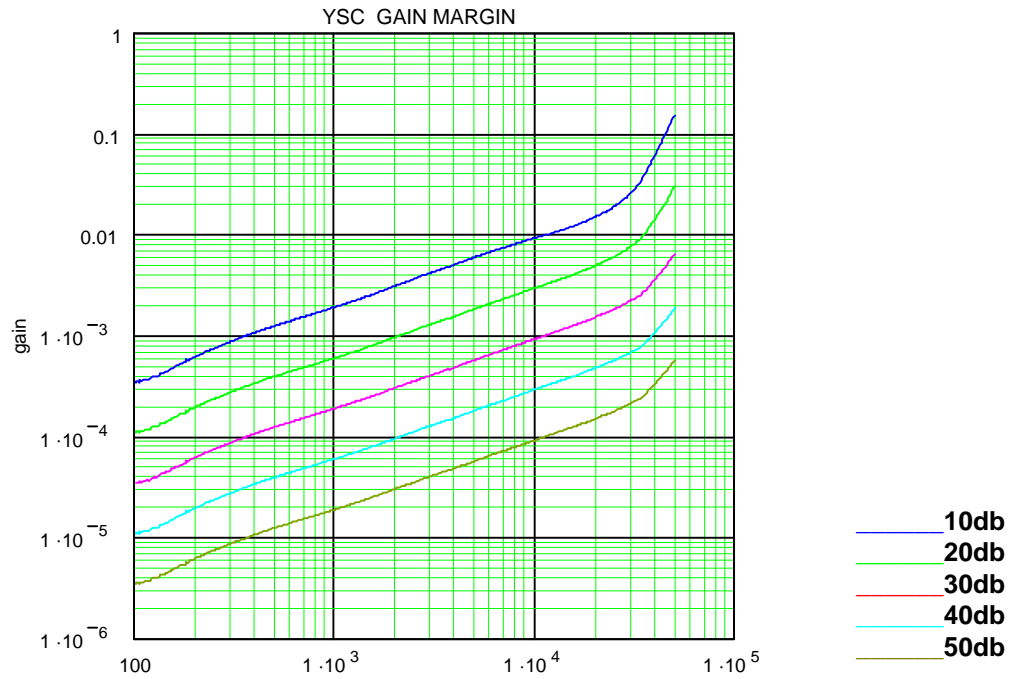

Figure 24. Young's Stability Curve – Gain Margin

Mechanical Specifications

Parameter	Device	Symbol	Min	Typ	Max	Unit
Dimension	AEH/ALH	L	-	2.40 [60.96]	-	in [mm]
	AEH/ALH	W	-	2.30 [58.42]	-	in [mm]
	AEH	H	-	0.50 [12.70]	-	in [mm]
	ALH	H	-	0.40 [10.16]	-	in [mm]
Weight	AEH		-	130 [4.60]	-	g [oz]
	ALH		-	110 [3.90]	-	g [oz]

PIN ASSIGNMENT			
1	+ V _{IN}	6	- Sense
2	Enable ON/OFF	7	Trim
3	Case (AEH version)	8	+ Sense
4	- V _{IN}	9	+ Output
5	- Output		

Note: Nominal diameter for Pins 5 & 9 = 0.08", remaining pins at 0.04"

OUTLINE DRAWING

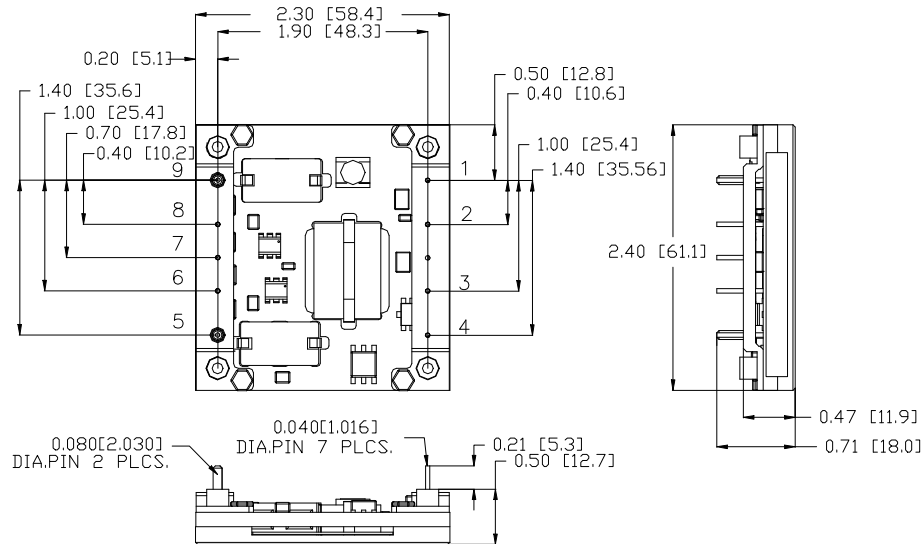

Figure 25. AEH60 - baseplate outline drawing (bottom view)

Mechanical Specifications (continued)

OUTLINE DRAWING

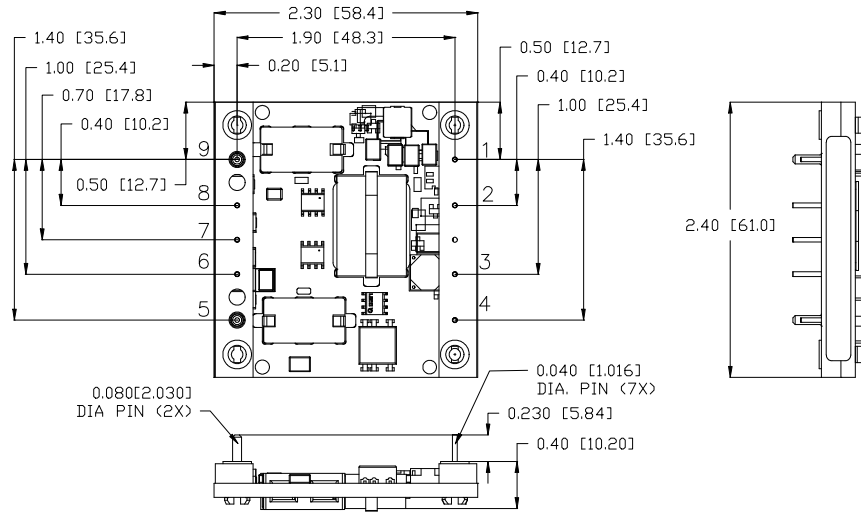

Figure 26. ALH60 - open-frame outline drawing (bottom view)

SOLDERING CONSIDERATIONS

The AEH/ALH series converters are compatible with standard wave soldering techniques. When wave soldering, the converter pins should be preheated for 20–30 seconds at 110 °C and wave soldered at 260 °C for less than 10 seconds.

When hand soldering, the iron temperature should be maintained at 425°C and applied to the converter pins for less than 5 seconds. Longer exposure can cause internal damage to the converter. Cleaning can be performed with cleaning solvent IPA or with water.

PART NUMBER CODING SCHEME FOR ORDERING

A	x	H60	y	48	z
----------	----------	------------	----------	-----------	----------

x	Construction
	E: Enhanced thermals; Heatsink adapted L: Low profile; Open Frame
y	Output Voltage
	F = 3.3V Y = 1.8V G = 2.5V K = 1.2V
z	Option
	N : Negative Enable No Suffix : Positive Enable

Please call 1-888-41-ASTEC for further inquiries or visit us at www.astecpower.com